

DWT-BASED DETECTION OF HIGH IMPEDANCE FAULT DUE TO LEANING TREES IN COMPENSATED MV NETWORKS

Nagy I. ELKALASHY

Helsinki University of Technology– Finland
nagy.elkalashy@tkk.fi

Hatem A. DARWISH

Minoufiya University – Egypt
h_a_darwish@yahoo.com

Abdel-Maksoud I. TAALAB

Minoufiya University– Egypt
taalab3@yahoo.com

Matti LEHTONEN

Helsinki University of technology- Finland
matti.lehtonen@tkk.fi

Mohamed A. IZZULARAB

Minoufiya University- Egypt
mizzularab@yahoo.com

ABSTRACT

Features of faults due to leaning trees are extracted using discrete wavelet transform (DWT) and an absolute sum of the detail coefficient d_3 over a period of power frequency cycle is used as a detector. DWT is processed on the residual voltage at different measuring nodes allocated in a wide area of the network and such correlation of DWT performance at different nodes can be carried out using distributed wireless sensors. Therefore, the fault detection is confirmed by numerous detectors. Other fault features that can enhance the detection security are that the initial transients are frequently repeated and therefore localized with each current zero crossing. The fault detection selectivity is carried out considering the multiplications of DWT detail coefficients of the residual current and voltage at each measuring nodes. A sum over two cycles is then computed to estimate the direction of the transient power and therefore to discriminate between the healthy and faulty sections. Test cases prove with evidence the efficacy of proposed technique.

INTRODUCTION

The electrical fault caused by a leaning tree is considered a high impedance arcing fault due to the high resistance of tree (several hundred ohms) and associated arcs [1]. Detection of high impedance faults are still major challenges for protection engineers [2].

There are several earthing concepts such as solidly, compensated and unearthing networks. The compensated networks are increasingly applied in Nordic Countries. Due to small earth fault currents in compensated networks, the transients' phenomena are considered for detection such faults [3]. The best signal processing techniques for extracting these features is the wavelet transform.

In [4-5], the fault due to leaning trees have been detected using DWT. It was found that associated arc reignitions with this fault type contributed to repeated initial transients in the network. In this paper, the study of this fault detection is extended to be discussed when it occurred in compensated networks. The fault due to a leaning tree occurring in 20 kV network (80% under compensation) is simulated by ATP/EMTP and the arc model is implemented using the universal arc representation. The system model is processed using ATPDraw.

PROPOSED TECHNIQUE PRINCIPLES

The proposed technique mainly depends on DWT and wireless sensor concept. As shown in Figure 1, phase voltages and branch phase currents are measured at each measuring node. The corresponding residual current and voltage are computed and they are extracted using DWT. The absolute sum of the residual voltage detail d_3 coefficient over a power cycle is computed for the fault detection purpose. A timer is used for determining the fault period and it can be implemented using a samples counter. In order to track the fault, the detail d_3 of the residual voltage and current at each measuring node is multiplied to compute the residual power of the frequency range 12.5-6.25 kHz where the sampling frequency is 100 kHz. Using the sum over a period of two power cycles, the power direction in the form of its polarity is utilized for determining which branch leads to the fault point. The fault tracking process is considered since the fault features appeared on the residual voltage details. The protection technique behaviour over a wide area of the network is collected using wireless sensors.

The wireless sensor concept is a modern insight used for various tasks with the objective of saving time and expense. Wireless sensors are distributed throughout the electrical network. The electrical quantities are then regularly transmitted from the different measuring nodes and investigated for several purposes such as load monitoring, fault detection and location. The availability of sensing devices, embedded processors, communication kits and power equipment enables the design of wireless sensors as depicted in the four major blocks in Figure 2 [6]. This paper will not explore for these issues in more depth. The point is that the wireless concept can be considered to gather data from different measuring nodes in the network.

SIMULATED SYSTEM

The system model can be divided into two main parts: the MV network model and the representation of the high impedance arcing fault. Figure 3 illustrates the single line diagram of an unearthing 20 kV, 5 feeders distribution network simulated using ATP/EMTP, in which the processing is created by ATPDraw [7]. The feeder lines are

represented using the frequency dependent JMarti model consistent with the feeder configuration given in Appendix. The neutral of the main transformer is earthed through a coil to achieve earth fault compensation degree of -31%.

The faults due to leaning trees are modeled using two series parts: a dynamic arc model and a high resistance. For the considered case study, the resistance is equal to 140 kΩ and the arc is modeled depending upon thermal equilibrium that is adapted as following [1]:

$$\frac{dg}{dt} = \frac{1}{\tau}(G - g) \tag{1}$$

$$G = |i|/V_{arc} \tag{2}$$

$$\tau = Ae^{Bg} \tag{3}$$

where g is the time-varying arc conductance, G is the stationary arc conductance, $|i|$ is the absolute value of the arc current, V_{arc} is a constant arc voltage parameter, τ is the arc time constant and A and B are constants. In [1], the parameters V_{arc} , A and B were found to be 2520V, 5.6E-7 and 395917, respectively. Considering the conductance at each zero crossing, the dielectric is represented by a variable resistance until the instant of reignition. It is represented using a ramp function of 0.5 MΩ/ms for a period of 1 ms after the zero-crossing and then 4 MΩ/ms until the reignition instant.

The universal arc representation is used for implementing the arcing equations (1), (2) and (3) [8]. Where the fault current is transposed into the TACS field using type 91 sensors. Therefore, the arc model is solved in the TACS exploiting integrator device type 58. In the next step, the computed arc resistance is sent back into the network using TACS controlled resistance type 91 and so on. Control signals are generated to distinguish between arcing and dielectric periods and therefore to fulfill the reignition instant after each zero-crossing.

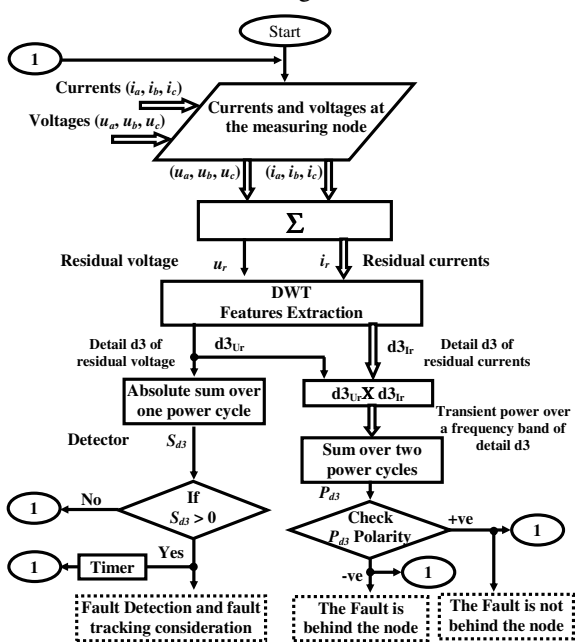

Figure 1 The proposed detection technique.

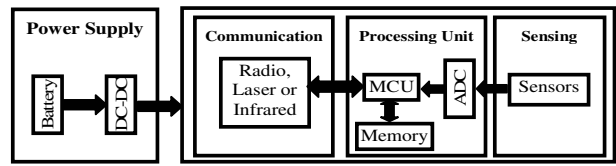

Figure 2 Architecture of the sensor node system [6].

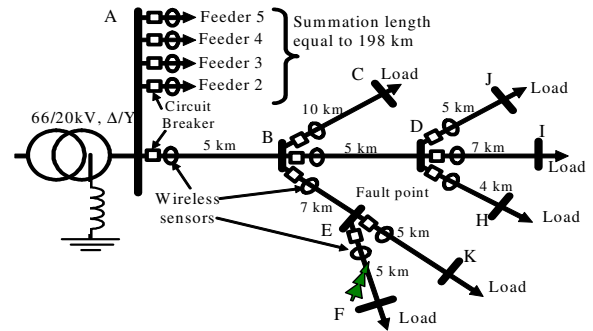
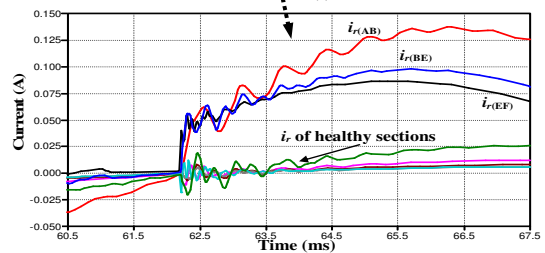
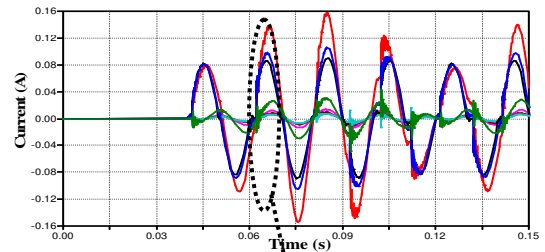
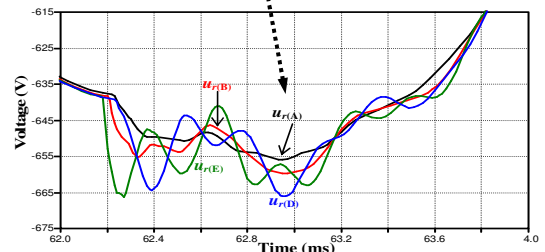
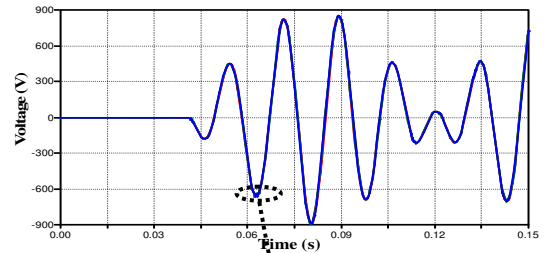

Figure 3 Simulated system (5 feeders).



a- Enlarged view of residual current waveforms (i_r).



b- Enlarged view of residual voltage waveforms (u_r).

Figure 4 The residual waveforms when fault occurred in section EF.

The aforementioned MV network and the fault modeling are combined in a single arrangement, as shown in the ATPDraw circuit illustrated in the Appendix. When phase-a to ground fault occurred in section EF, corresponding

residual voltage and current waveforms are shown in Figure 4. The fault instant is at 40 ms. The initial transients due to arc reignitions are obvious in the residual waveforms and it is required to extract them using a suitable signal processing technique such as DWT.

DWT-BASED FAULT DETECTION

Wavelets are families of functions generated from a single function, called the mother wavelet, by means of scaling and translating. The scaling operation is used to dilate and compress the mother wavelet to obtain the respective high and low frequency information of the function to be analyzed. Then the translation is used to obtain the time information. In this way a family of scaled and translated wavelets is created and it serves as the base for representing the function to be analyzed. The DWT is in the form:

$$DWT_{\psi} f(m, k) = \frac{1}{\sqrt{a_o^m}} \sum_n x(n) \psi\left(\frac{k - nb_o a_o^m}{a_o^m}\right) \quad (4)$$

where $\psi(\cdot)$ is the mother wavelet that is discretely dilated and translated by a_o^m and $nb_o a_o^m$, respectively. a_o and b_o are fixed values with $a_o > 1$ and $b_o > 0$. m and n are integers. In the case of the dyadic transform, which can be viewed as a special kind of DWT spectral analyzer, $a_o = 2$ and $b_o = 1$.

Several wavelet families were tested to extract the fault features using the Wavelet toolbox incorporated into the MATLAB program [9]. Daubechies wavelet 14 (db14) is found appropriate for localizing this fault. The Details d3 including the frequency band 12.5-6.25 kHz of the residual voltages are investigated at different measuring nodes as shown in Figure 5. It is obvious that the initial transients due to arc reignitions are frequently localized. The absolute sum value of the voltage detail d3 over a period of the power frequency is computed in a discrete form at each measuring node, as in [10]:

$$S_{d3}(k) = \sum_{n=k-N+1}^k |d3_{Ur}(n)| \quad (5)$$

where $S_{d3}(k)$ means the detector in the discrete samples. n is used for carrying out a sliding window covering 20 ms and N is a number of window samples. S_{d3} performance is shown in Figure 6. The detectors are high not only at the starting instant of the fault occurrence but also during the fault period, which improves the protection security.

To estimate the faulty section, Figure 7 can help for illustrating the proposed technique, which is an enlarged view of the details d3 of the residual voltage and currents at node A. It is recognizable that the details d3 of the voltage and currents of the healthy feeders are in-phase. However, the detail of the faulty feeder residual current is out of phase. This shifting can be supervised by multiplying the details of the residual voltage ($d3_{Ur}$) and current ($d3_{Ir}$). It can be considered to be the harmonic-band power over the frequency range 12.5-6.25 kHz. Then its polarity is estimated using summation over a period of two power frequency cycles. This power is computed as:

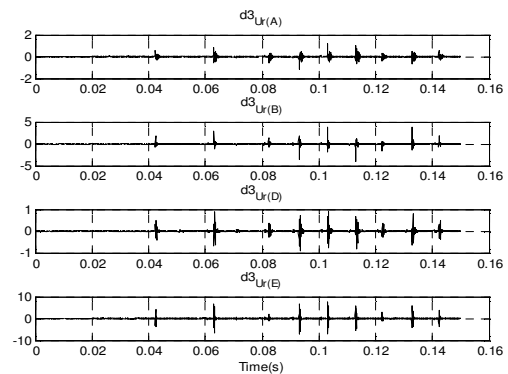

Figure 5 Details d3 of the residual voltages at nodes A, B, D and E.

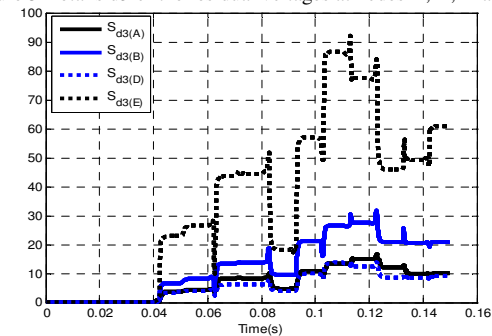

Figure 6 The detector S_{d3} of the voltage details at nodes A, B, D and E.

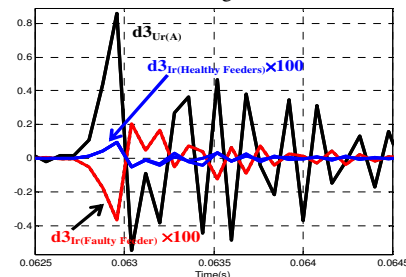

Figure 7 Enlarged view of residual details at node A.

$$P_{d3}(k) = \sum_{n=k-2N+1}^k |d3_{Ur}(n) \times d3_{Ir}(n)| \quad (6)$$

where $P_{d3}(k)$ is used for the discrimination and its polarity is used to track the fault point. The discriminator performance P at different measuring nodes is shown in Figure 8. Its polarity is positive for healthy feeders and negative for faulty feeder as shown in Figure 8-a, Figure 8-b points out the fault track is in section BE and Figure 8-c illustrates that the fault is in section EF. So, the fault route is estimated.

CONCLUSION

DWT-based detection of high impedance arcing fault due to leaning trees has been investigated in compensated MV network. The fault detector was carried out using the absolute sum over power cycle for the residual voltage detail d3 coefficients. The periodicity of the arc reignitions gives a specific performance for the DWT with this fault type and the results ensure the fault detection. The fault tracking has been estimated using the polarities of the power computed by multiplying the detail d3 coefficients of the residual voltage and current.

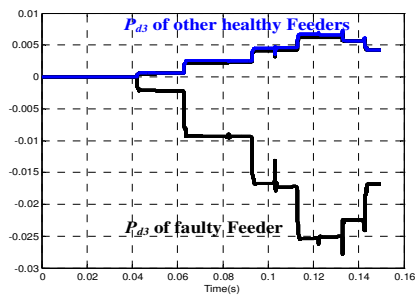

a- The discriminator P_{d3} at node A to determine the faulty feeder.

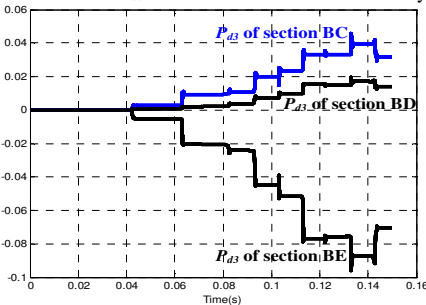

b- The discriminator P_{d3} at node B to determine the faulty section.

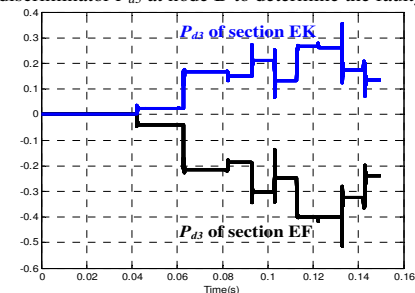

c- The discriminator P_{d3} at node E to determine the faulty section.

Figure 8 The discriminator P_{d3} when the fault occurred in section EF.

APPENDIX

Figure 9 illustrates the ATPDraw network. It contains the MV network, the universal arc representation and the residual current and voltage waveforms computation. The feeders are represented using a frequency dependent JMarti model. Their configuration is shown in Figure 10.

REFERENCES

- [1] N. Elkalashy, M. Lehtonen, H. Darwish, M. Izzularab and A. Taalab, 2007, "Modeling and Experimental Verification of a High Impedance Arcing Fault in MV Networks" Accepted at *IEEE Trans. Dielectric and Electrical Insulation*.
- [2] Report of PSRC Working Group D15, 1996, "High Impedance Fault Detection Technology".
- [3] G. Druml, A. Kugi and O. Seifert, 2003, "A New Directional Transient Relay for High Ohmic Earth Faults" *17th International Conference and Exhibition on Electricity Distribution, CIRED*.
- [4] N. Elkalashy, M. Lehtonen, H. Darwish, A. Taalab and M. Izzularab, 2007, "DWT-Based Extraction of Residual Currents throughout Unearthed MV Networks for Detecting High Impedance Faults due to leaning Trees" Accepted at *European Transaction on Electrical Power ETEP*.

- [5] N. Elkalashy, M. Lehtonen, H. Darwish, A. Taalab and M. Izzularab, 2007, "DWT-Based Detection and Transient Power Direction-Based Location of High Impedance Faults Due to Leaning Trees in Unearthed MV Networks" Submitted to *International Conference on Power Systems Transients, IPST*.
- [6] M. Vieira, C. Coelho, D. da Silva, J. da Mata, 2003, "Survey on Wireless Sensor Network Devices" *Emerging Technologies and Factory Automation, ETFA'03*, pp. 537-544.
- [7] L. Prikler and H. Hoildalen, 1998, *ATPDraw users' manual*, SINTEF TR A4790.
- [8] H. Darwish and N. Elkalashy, 2005, "Universal Arc Representation Using EMTP," *IEEE Trans. on Power Delivery*, Vol. 2, no. 2, pp 774-779.
- [9] *Wavelet Toolbox for MATLAB*, Math Works 2005.
- [10] J. Haung, C. Shen, S. Phoong and H. Chen, 2006, "Robust Measure of Image Focus in the Wavelet Domain" *International Symposium on Intelligent Signal Processing and Communication Systems, ISPACS2005*.

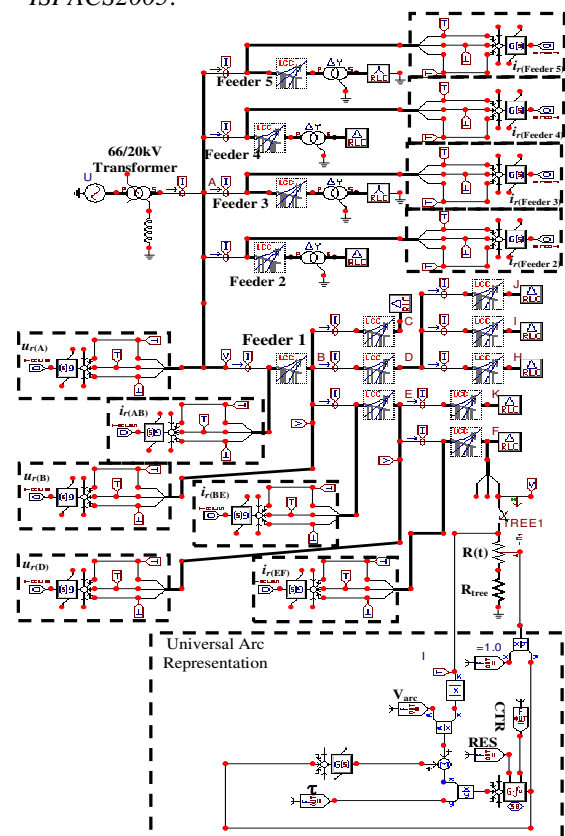

Figure 9 The ATPDraw network.

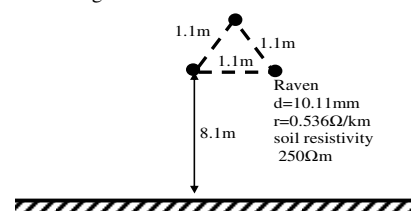

Figure 10 The feeder configuration.